

Al¹³ | ALUMINUM RAILING

MOUNT BRACKETS & PANELS

OPTION 1: EVOLVE EXTERNAL BRACKETS

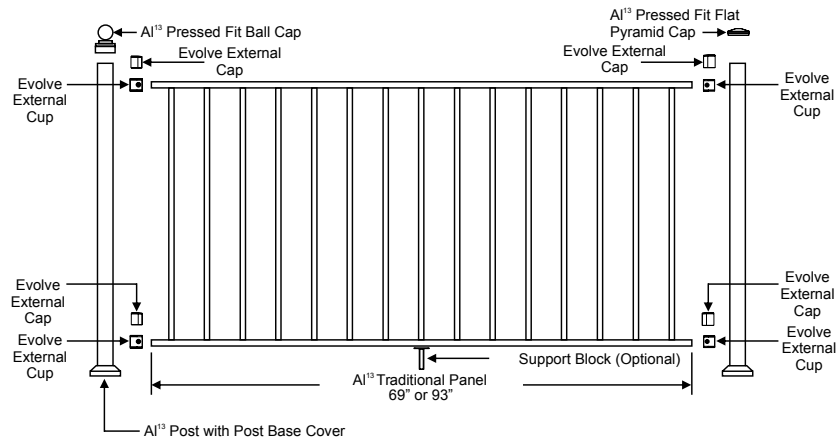
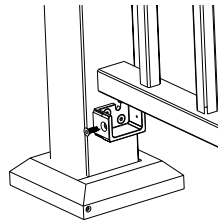

MOUNT POSTS

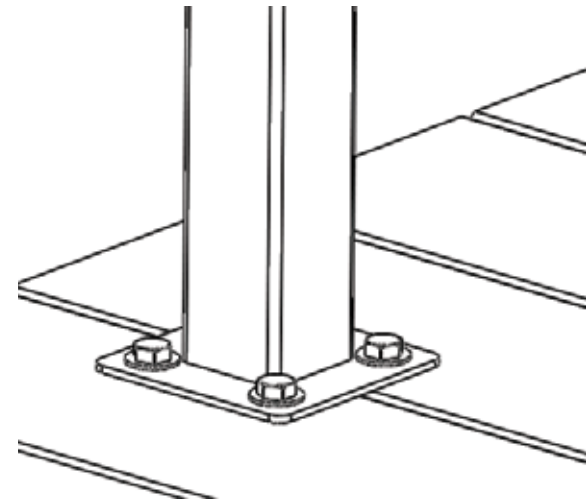

Fortress Posts must always be secured to the deck framing and should never be attached to only the deck boards.

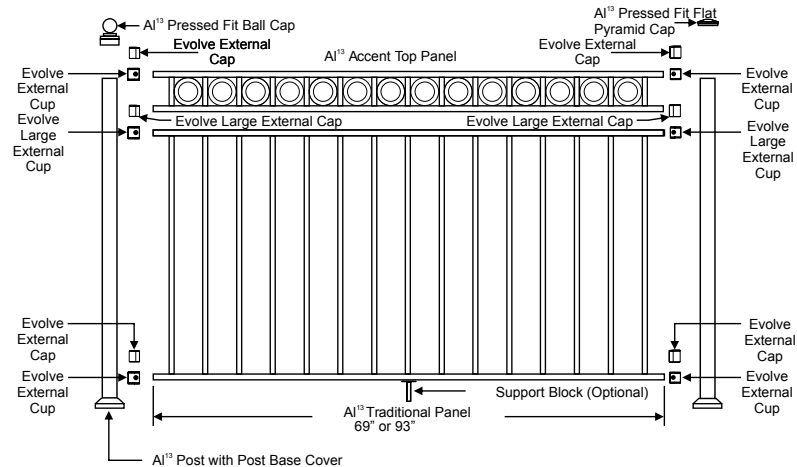
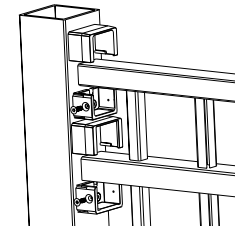

OPTION 2: EVOLVE INTERNAL BRACKETS

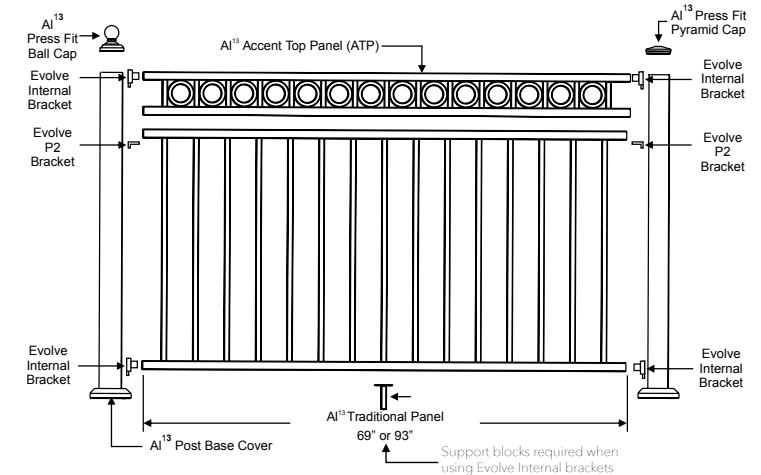
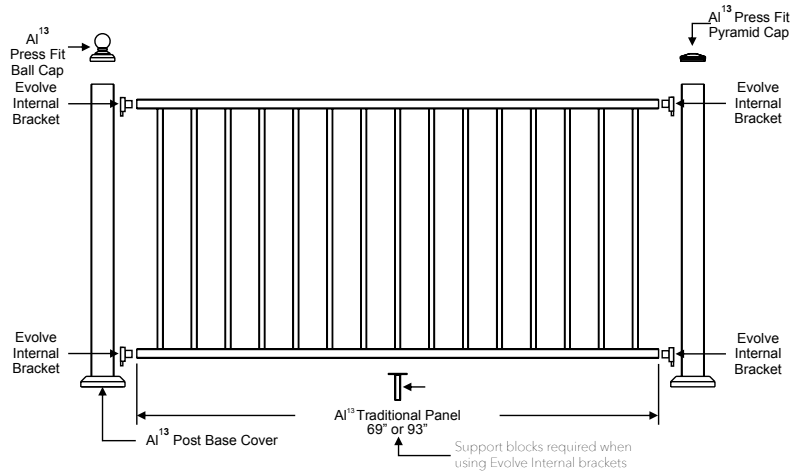
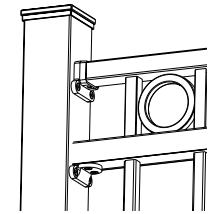
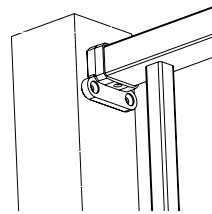

OPTION 3: EVOLVE P2 BRACKETS

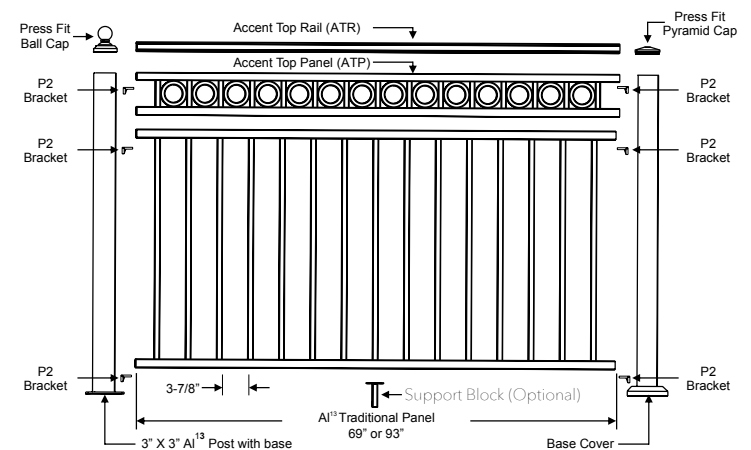
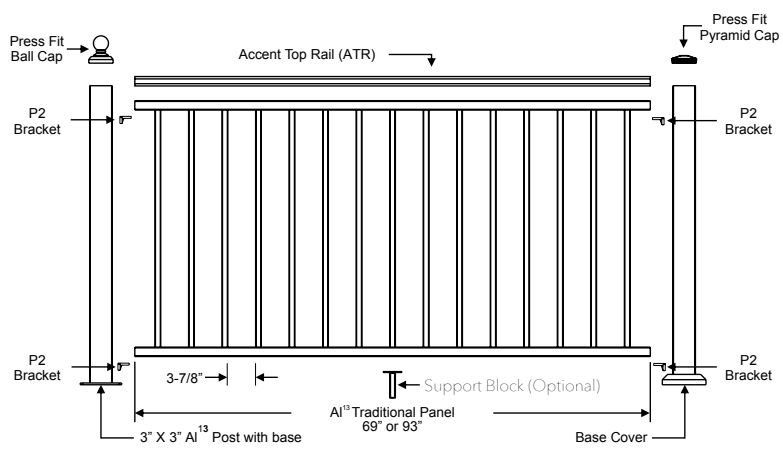
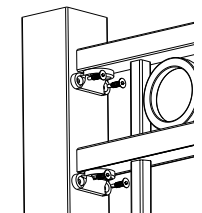
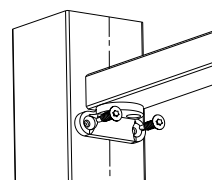

EVOLVE P2 BRACKETS: ANGLE/MITER

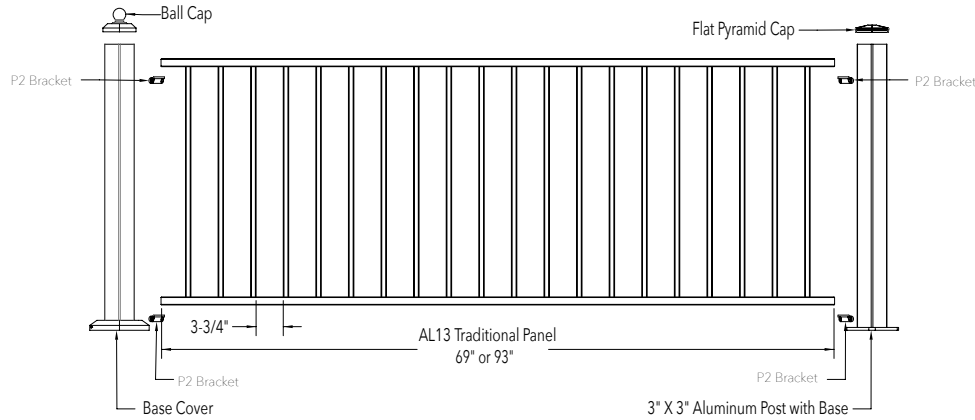

ANGLE WITH EVOLVE ANGLE BRACKET

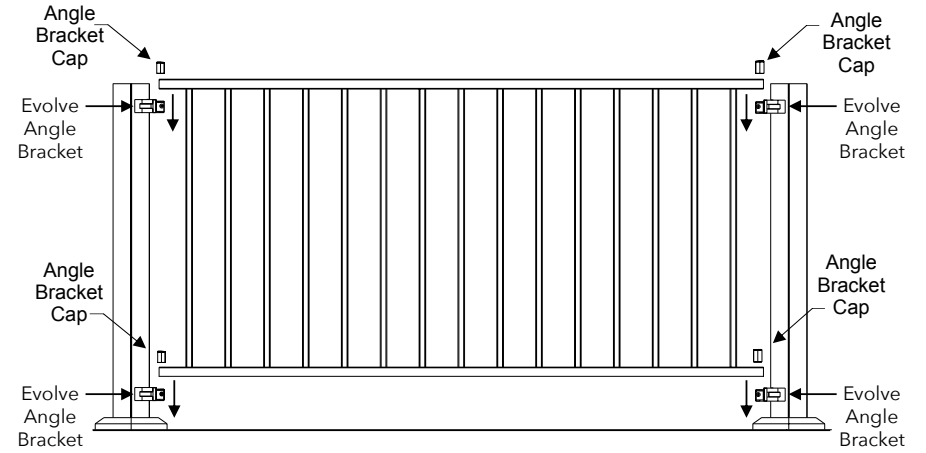

STAIR WITH P2 STAIR BRACKET

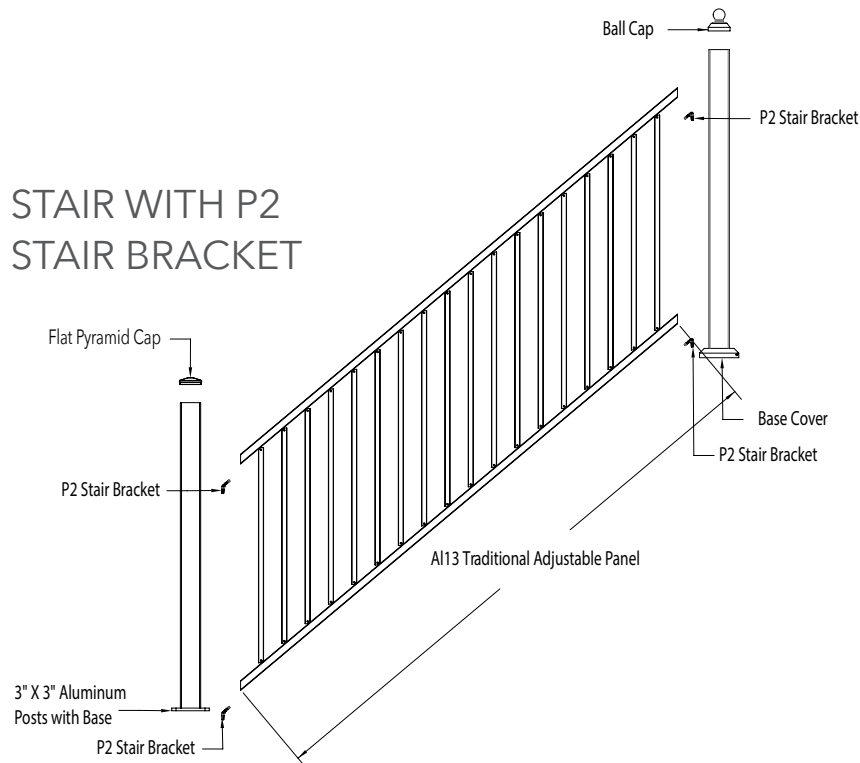

STAIR WITH EVOLVE STAIR BRACKET

